

To Bee Or Not To Bee



LEVEL: Grades K-3

SUBJECTS: Science, Language Arts, Math, and Social Studies

AZ ACADEMIC STANDARDS: 1AD-F3, 1AD-F2, R-F2, R-F3, R-F5, R-F6, R-F7, R-F8, W-F1, W-F2, W-F4, W-F5, LS-F2, VP-F1, VP-F3, 2M-F1, 3M-F1, 3M-F2, 5M-F2, 1SS-F1, 3SS-F2, SC01-S1C3, SC01-S4C1, SC02-S1C3, SC02-S4C1, SC03-S1C3, SC03-S3C2, SC03-S4C1

MATERIALS

Pictures of a bee with body parts labeled, cotton balls, samples of honey, drawing paper, straws, pattern blocks, plastic spoons, wax, paper, glue, chalkboard, chalk, resealable bags of food (crackers, cookies, nuts, grapes) hand lenses, honey in the comb, bug cage or jar, chart paper, wax paper, rice, food coloring.

VOCABULARY

bee, beehive, flower, fruit, pollen, honeycomb, honey, wax, eggs, larvae, nectar, drone, queen, worker, colony, apiaries, and beekeeper. (words defined at end of lesson)

RELATED LESSONS

Those Busy, Buzz'n
Worker Bees
Buzzing Bee's Wardrobe
Do The Honeybee Dance!
How Busy are Bees?

SUPPORTING INFORMATION

Apiaries require an ample supply of nectar and pollen and are usually kept where nectar-producing plants such as clover or eucalyptus are abundant. Some beekeepers have migratory apiaries and transport their bees to suitable forage. Apiaries

may consist of from 1 to 200 hives, depending on the means of the beekeeper and the flower resources available.

Commercial beekeepers who make their entire living from bees often keep hundreds or thousands of hives.

Most North American beekeepers have standardized their equipment, using boxes (called supers) that hold ten wood-bound comb frames. The standard hive is called the Langstroth hive, and its dimensions are those described by its inventor in 1851. Present-day apiculturists believe that the honey bee is an adaptable animal that can survive under a variety of situations and conditions.

Most bees have specialized branched or feathery body hairs that help in the collection of pollen. Female bees, like many other hymenopterans, have a defensive sting. Some bees produce honey from flower nectar. Honey bees and stingless bees commonly hoard large quantities of honey—a characteristic that is exploited by beekeepers, who harvest the honey for human consumption (see Beekeeping). There are about 20,000 species of bees worldwide. Some species may not yet have been discovered, and many are either not named or have not been well studied. Bees are found throughout the world except at the highest altitudes, in Polar Regions, and on some small

BRIEF DESCRIPTION

Students will do a variety of activities to show the importance of bees in the food chain, and the importance bees play in pollination. In the process they will learn how honey is made.

OBJECTIVES

The students will make a list of what they know about bees and what they want to learn, so they will have a better understanding of bees. They will become aware of the importance of pollination and how it is carried on. They will learn about the complex social behavior and how they communicate. They will review and have an understanding of beehives and how honey is made; they will then realize that the bee is a good insect and that they are important to our everyday life.

ESTIMATED TEACHING TIME

1 hour per day over a 2 week period.

SUPPORTING INFORMATION (cont'd)

oceanic islands. The greatest diversity of bee species is found in warm, arid or semiarid areas, especially in the American Southwest and Mexico. Bees range in size from tiny species only 2 mm (0.08 in) in length to rather large insects up to 4 cm (1.6 in) long. Many bees are black or gray, but others are bright yellow, red, or metallic green or blue.

The honey bee community consists of three structurally different forms—the queen (reproductive female), the drone (male), and the worker (nonreproductive female). These castes are associated with different functions in the colony; each caste possesses its own special instincts geared to the needs of the colony.

Honey bees have become the primary source of pollination for approximately one-fourth of all crops produced in the United States and some other countries. The value of the crops that rely on such pollination has been estimated as high as \$10 billion annually in the United States. Examples of fruit crops that rely on honey bees are almonds, apples, apricots, avocados, blackberries, blueberries, cantaloupes, cherries, cranberries, cucumbers, pears, raspberries, strawberries and watermelons. The seeds of many vegetables are also produced with honey bee pollination; examples include alfalfa, asparagus, broccoli, brussels sprouts, cabbage, carrots, clover, cotton, onions, radishes, squash, sweet clover, and turnips. Honey bees are the sole source of honey and beeswax, a fine wax with unusual qualities. Honey bees also produce propolis, a

gummy substance made from tree sap that has antibacterial properties, and royal jelly and pollen for human consumption. Honey bee venom is extracted for the production of antivenom therapy and is being investigated as a treatment for several serious diseases of the muscles, connective tissue, and immune system, including multiple sclerosis and arthritis.

Honey bees have many characteristics common to all insects. Insects have a hard outer covering called an exoskeleton, rather than an internal skeleton like vertebrates. The exoskeleton, which is made of a material called chitin, helps to protect the internal organs of the insect and helps prevent desiccation (drying out). In order to grow, the insect must shed the exoskeleton. Insects have three body regions: the head, thorax and abdomen. The head contains the sensory organs, and appendages for ingestion. The thorax contains the appendages for locomotion, the legs and wings. The abdomen contains the organs for digestion and reproduction.

There are two female castes of bees in each colony: workers and queens. The most important one is the **queen bee**. She is the egg machine in the hive and can lay up to 2000 eggs per day, if there are enough worker bees to incubate them. Without a queen mother, the colony would soon dwindle to nothing.

Worker bees are responsible for all of the honey, beeswax and pollinating activities for the entire hive. In the middle of summer, their population will be as high as 40,000 individuals. Why would beekeepers want this? Hint:

one bee collects only 1/12 of a teaspoon of honey!

Drones are male bees (not a caste) and congregate in special flight areas looking for young queens with which they can mate. In the summer time, they will number up to 1500 or so, but come fall, the workers will drag them out of the hive to die. Since they cannot sting, they are defenseless against attack by birds, toads or skunks which love to eat bees.

BEE COMMUNICATION

Bees are very successful in bringing back large amounts of nectar because they are able to communicate the location and kinds of food available. They do this by a series of body movements called **dancing**. A returning forager bee lets the house bees taste the nectar, and smell the scent of the flower that adheres to her. As she starts to dance, the direction she points to relates to the sun's position at that time. Her body movements or "wags," indicate the distance to the food. By touching the dancer with their antennae, other bees can decipher such movements and odors, and make a kind of road to the flower.

When worker bees find food, they move in figure-eight patterns to tell others where the food is in relation to the sun. For example, if the food is located 45 degrees to the right of the sun, the bee faces 45 degrees to the right and weaves a figure-eight pattern; the closer the food, the quicker and tighter the movements.

Bees come to flowers to get nectar. As the bees search for food, they are dusted with powdery yellow pollen. They carry grains of pollen from one flower to the next. This allows the flowers to form fruits and seeds. A flower is a bee "magnet." Its scent and

color attract bees. To a bee, flowers glow with colors that you cannot see. A red flower

SUPPORTING INFORMATION (cont'd)

may seem blue or purple to a bee. The flower looks different to the bee because the bee can see ultraviolet light. People cannot see this type of light. A bumblebee gathers pollen as well as nectar when it visits flowers. The bee collects nectar in its crop, near its stomach. It collects pollen on its hind legs. Brushy hairs on each hind leg form a sort of pollen "basket." When the pollen baskets are full, the bee flies back to its nest. At the nest, the bumblebee shares the nectar and pollen with other members of its colony. Bees store extra pollen and nectar in little wax chambers called honey pots. This stored food is very important. It will be eaten by young bees as they develop into adults.

As insects, honey bees pass through four distinct life stages: the egg, larva, pupa and adult. Complete metamorphosis takes between 16 and 24 days depending on the sex of the developing bee. A queen bee lays an egg in an individual wax cell. The egg hatches into a white legless larva on the fourth day. The larva feeds on royal jelly and beebread until it reaches mature size and then spins a cocoon around itself. The cell is capped with wax and the larva transforms into the pupa. The pupa develops into a mature adult bee inside the capped cell. When fully developed, the mature bee chews its way out of the cell. Adult worker bees live approximately 45 days during the summer months. About one-third of the total human diet is derived directly or indirectly from insect-

pollinated plants. An estimated 80 percent of insect crop pollination is accomplished by honey bees. Honey bees are needed to pollinate a variety of fruits, berries, vegetables, tree nuts, oil seeds and legumes. A 1999 Cornell University study reported that the direct value of honey bee pollination is over \$14 billion annually. This value only reflects the value of increased crop yields and quality due to honey bee pollination.

Honey bees pollinate crops in all 50 states. In Arizona they are big pollinators of cantaloupes, honeydew and watermelons.

Honey bees are one of science's greatest mysteries because they have remained unchanged for twenty million years, while the world changed around them.

Pilgrims brought the first honey bees to North America in the 1600s. By the 1850s, honey bees were found all across the continent in California. Pioneers used boxes to trap honey bees and then released them so that the bees could be followed back to the hive. In 1852, a teacher and part-time beekeeper invented the movable-frame beehive and the honey business boomed. Throughout the year, honey bees face many environmental hazards; heat waves, freezing weather and honey thieves, like bears and skunks. Beekeepers keep the hives protected from the weather and make sure they are always near plenty of flowers and water.

Beekeepers raise colonies of bees for several products, the most important of which is honey. Anyone who keeps bees is performing an important ecological service as well, because many plants are dependent on bees for pollination.

There are an estimated 139,600 to 212,000 beekeepers in the United States. The vast majority are hobbyist beekeepers. An estimated 1,600 beekeepers are commercial beekeepers who manage more than 300 colonies of bees each. About one-half of commercial beekeepers are migratory beekeepers. They rent their bees to farmers, following the pollination seasons of the various crops.

Modern beehives consist of wooden box-like sections stacked on top of each other. Each box holds 8-10 wooden frames, each containing a thin sheet of wax foundation. The bees build their combs on these foundations provided by the beekeepers, and therefore save time and effort in honey making.

Honey is stored in the combs in the upper parts of the hive. When the bees have filled the combs in this upper section with honey and covered them with wax caps, the beekeeper takes them away to extract the honey and sell the wax for many products.

Worker bees are very important; they must collect enough food to feed the colony in warm weather and to store food for cold weather when there are no flowers. A honeybee colony uses 50 to 75 pounds of pollen each year. Once a worker starts to collect food she does not live long, only about 14 days. Some people may be allergic to bee stings and may require medical care. Stingers should be scraped from the skin, because pulling or squeezing a stinger actually releases more venom. Once the stinger is removed wash the area with soap and water. Apply an ice pack to help the pain and swelling. Thanks to the bees and flowers, we have a variety of foods.

GETTING STARTED

Gather any books (A Child's Book of Insects, Ants, and Bees, Bees and Honey, Honey Bees), visual aids (Honey Bee, McGraw-Hill

GETTING STARTED (cont'd)

Study Prints, or films: Life Cycle of the Honey Bee, Bioscience Series National Geographic Society that will help explain about bees). Make transparencies of a bee, beehive and flower, which can be found in the activity section. Make copies of any student activity sheet you choose to use from activity section. Collect enough cotton balls, straws, spoons, hand lenses, plastic bags, for all students. Send parent letter home requesting help with the different food snacks needed for tasting and smelling. Set up area with extra space and put chart paper, drawing paper, glue, scissors, and crayons. If possible buy honey in the comb from a natural food store and bring to class for observation.

PROCEDURES

1. Make a chart listing what students know about bees, what they don't know, and what they would like to learn.
 - a. Is a bee an insect? (Insects have 6 legs and 3 body sections. Insects usually have antennae and wings as well).
 - b. Show bee transparency and review parts of the bee and their names. Students explore structure of the honey bee body and make Bumble bee mobile (see activity sheet).
 - c. Review basic body parts and discuss the importance of various body parts of worker bees and how these function for hive survival. Students may construct worker bee models using various classroom/household

materials and art supplies to reinforce lesson.

2. Why is pollination important? (Pollen is transferred from the stamen (male part) to the pistil (female part). It sets things in motion for fertilization to take place so seed or fruit can be produced). If there was no pollination, no seeds or fruits would be produced.

- a. Students pretend cotton balls are bees, roll the balls in flowers to collect pollen, make paper flowers, place flowers on mural for bees to visit, and learn about pollen and nectar. The students then pretend they are bees (sucking fruit juice through straws) using their proboscis to obtain nectar to make honey.

3. Students learn how pollen can be transferred from one flower to another by way of insects and wind.

- a. Prepare three bowls of instant rice using the three different colors of food coloring in the water. Spread each color of rice out on waxed paper to cool and keep grains from sticking together. Once dry, place each color of rice in large plastic bag. Divide class into teams of 4 - 5 students. Give each team newspaper to cover work area, hairbrush to represent a bee, a handful of each color of cooked rice. Have students place the bristles of the brush in color "A" of rice then into color "B" of rice. What happens to rice (pollen) when the brush (bee) moves from one pile to the other. Next, have students blow on the color "A" pile in the direction of the color of the "C" pile. What happens? Are the colors mixed? Which method wasted more rice (pollen)?

4. How do bees know where to go to get food? (Bees communicate with each other by dance).

- a. Brainstorm with students ways animals communicate; for example dogs bark, frogs croak, and crickets chirp. Explain that bees communicate through dancing - they wiggle slowly or quickly in a figure eight pattern to tell others where food can be found. Draw bee dance pattern on the board and invite volunteers to demonstrate the movements. (Round dance when food is close goes round and round, first one way and then the other). (Waggle dance if flower is more than 100 yards away. The bee dances a half circle in one direction, turns, and runs straight while wagging her abdomen. Then she dances a half circle in the other direction to form a figure-eight). Divide the class into small groups and take to a large play area. Give each group a bag of food and ask them to secretly hide the treats. Have groups take turns communicating to others where food can be found by wiggling slowly or quickly in figure-eight patterns- the closer classmates are to the food the faster the dance movements.
- b. Review how bees tell each other where food is located, why bees dance quickly and what are other ways animals communicate.

5. How are hives made and what function do they have? A hive is made of hexagon cells. Cells are used for raising bees, storing pollen and honey.
 - a. Students discover that a honeycomb is made of wax, learn how bees hang in chains while making honeycomb cells, give wax scales to their paper bees, and work together as a class to build a paper hive.
6. Buy honey in the comb and bring to class. Examine honeycomb with hand lenses.

Explain that the comb is built by honeybees out of wax which is secreted from their bodies. In the cells of the honeycomb, nectar collected from flowers is deposited and eggs are laid.

a. Let the children look at, feel, smell, and taste the honey and the beeswax and

PROCEDURES (cont'd)

describe their observations. Also talk about the size and shape of the cells in the honeycomb.

b. How does the beeswax feel? How does it taste? Are the cells the same shape? What shape are they? Are all cells the same size?

7. Using pattern blocks have them draw beehives by tracing around the hexagonal shapes. Make a number of shapes put together and display in classroom.

8. Research the ways in which honey is used. Set up a field trip to a grocery store. Have students work in groups or pairs and see how many products they can find that contain honey. Back in the class room, discuss and group findings. If you cannot go to a store have students bring in different items and discuss or graph these items.

9. Bring in different kinds of liquid honey (at least three) taste and observe color and flavor of honey depending on the nectar source visited by the honey bees. Discuss which is the favorite honey of the class and which honey might be produced in the state.

EVALUATION OPTIONS

1. Go back to chart from beginning and determine what the class has learned, what they need to review and see if what they thought they already knew was right.

2. Ask students to discuss their most interesting activity and why they liked it.

3. Keep a science journal of each activity. Have students pair up and read to each other comparing journals.

4. Write a story to see if their attitudes towards bees are the same or different. Do they think bees are good or bad?

5. Role-play the importance of pollen gathering and how bees communicate.

6. Record five things each student learned about bees. Make a class book with all findings and have students illustrate the book.

EXTENSIONS AND VARIATIONS

1. Discuss where honey comes from and how do animals and people use honey.

2. Study the parts of a flower and their names.

3. Invite a beekeeper to your classroom.

4. Students observe and compare simulated bee dances. Observe backyard bees to see which flowers the bees prefer and the movements they make. Share observations with classmates.

5. Capture a bee in a jar and let children observe for a short while before letting it go. Talk about the sound the bee makes. When does it make the buzzing sound?

6. Invite a farmer to discuss how bees (and other insects) affect crops.

7. Encourage students and their families to visit local beekeepers to watch bees in action.

8. Collect books, poems, videos, art and music that relate to bees. Discuss how literature portrays bees. Is it good, bad, scary or indifferent?

9. Write a Haiku poem with a bee theme.

RESOURCES

Cole, Joanna. *An Insect's Body*, William Morrow & Co., 1984.

Carle, Eric. *The Honeybee and the Robber: A Moving Picture Book*, Putnam Publishing, 1981.

Grove, Sandra Ford and Dr. Judi Hechtman, *Crawling Creatures*, Creative Teaching Press, 1997.

Hoberman, Mary Ann, *A House is a House for Me*, Viking Penguin, New York, 1978.

Lobel, Arnold, *The Rose in my Garden*. Greenwillow Books, New York, 1984.

National Honey Board, *The Honey Files*, Longmont, Co., 2001.

National Honey Board, *The Honey Files: A Bee's Life*; videotape, produced by National Honey Board, 2001.

Once Upon A Gems Guide, Lawrence Hall of Science, University of California at Berkeley, 1996.

Pascoe, Elaine, *How and Why Insects Visit Flowers*, Creative Teaching Press, 2000.

Westley, Joan, *Insects and Other Crawlers*, Ideal School Supply, 1999.

Insect Lore Products, P.O. Box 1535, Shafter, CA 93263, 1-800-LIVE-BUG (distributes live insects)

McGuffee, Julie, *Hands on Crafts for Kids*, www.craft4kids.com

Consult your state and local beekeepers association, state Farm Bureau, cooperative extension, cals.arizona.edu and other organizations.

EDUCATORS' NOTES

CURRICULUM DESIGN

Anna S. Ogle

Grade 2

Picacho School

Picacho, Arizona

The Honey Bee Body

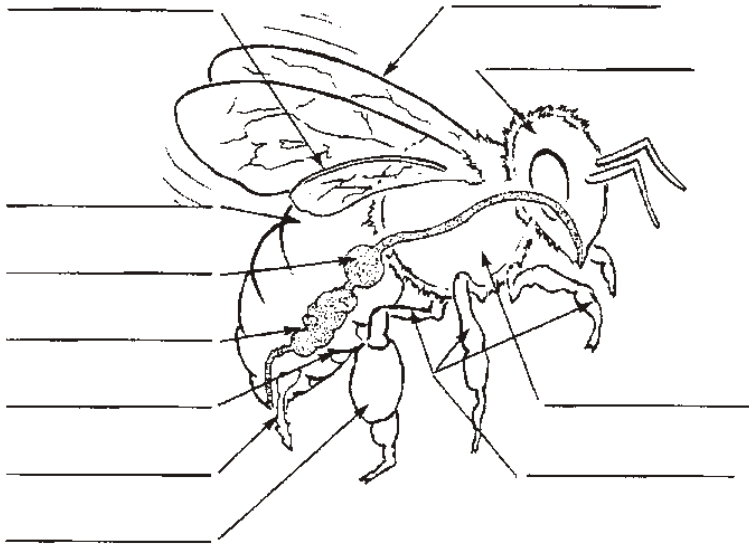

Label the following:

- Abdomen
- Fore wing
- Head
- hind wing
- honey sac
- Legs
- Midgut or ventriculus
- Pollen basket
- Stinger
- Thorax
- Wax gland

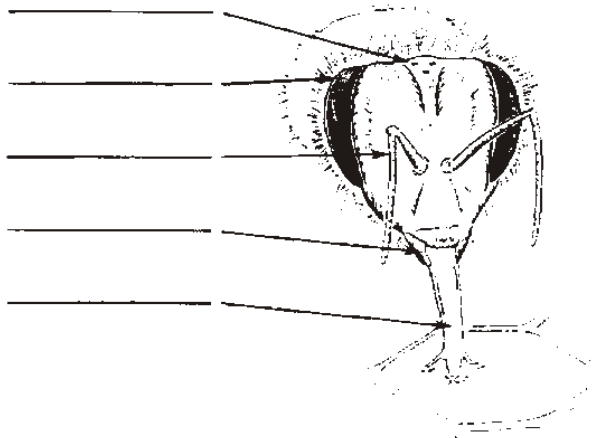

Label the following:

- Antenna
- Compound eye
- Mandible
- Ocellus
- Proboscis or tongue

This Arizona Grown Specialty Crop Lesson Plan was paid for by a grant from the Arizona Department of Agriculture's Office of Marketing and Outreach.

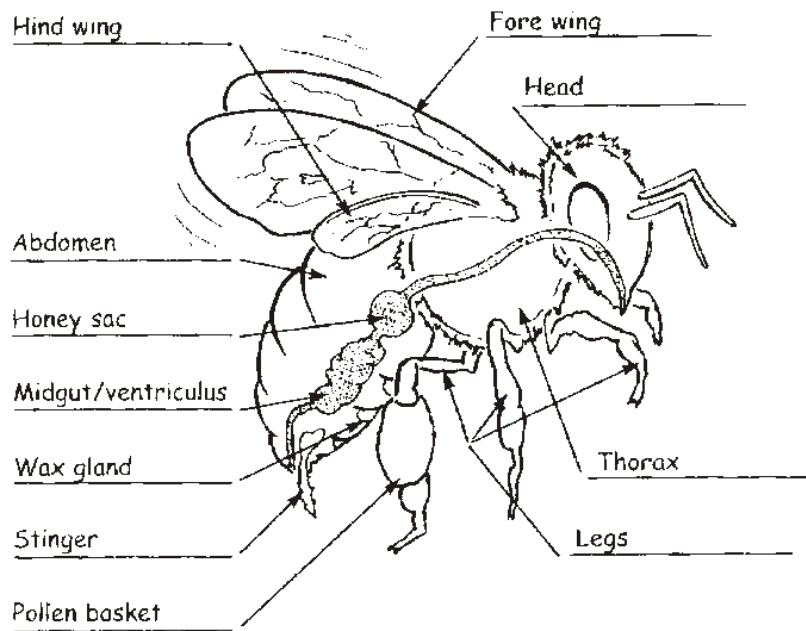

Label the following:

- Abdomen
- Fore wing
- Head
- Hind wing
- Honey sac
- Legs
- Midgut or ventriculus
- Pollen basket
- Stinger
- Thorax
- Wax gland

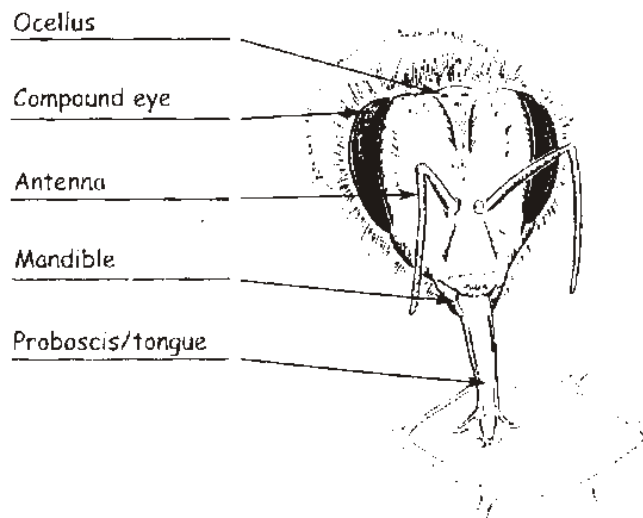

Label the following:

- Antenna
- Compound eye
- Mandible
- Ocellus
- Proboscis or tongue

PARTS OF A FLOWER

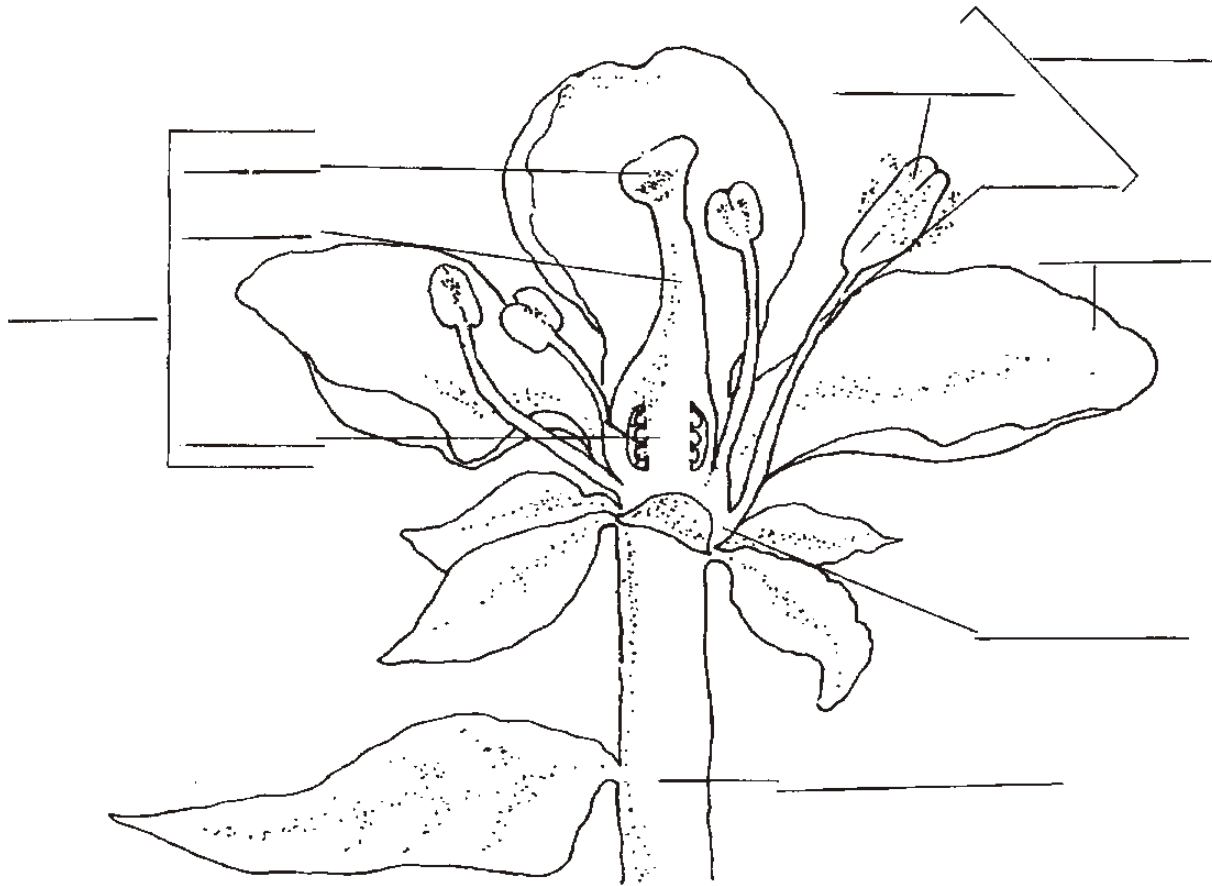

PARTS OF A FLOWER

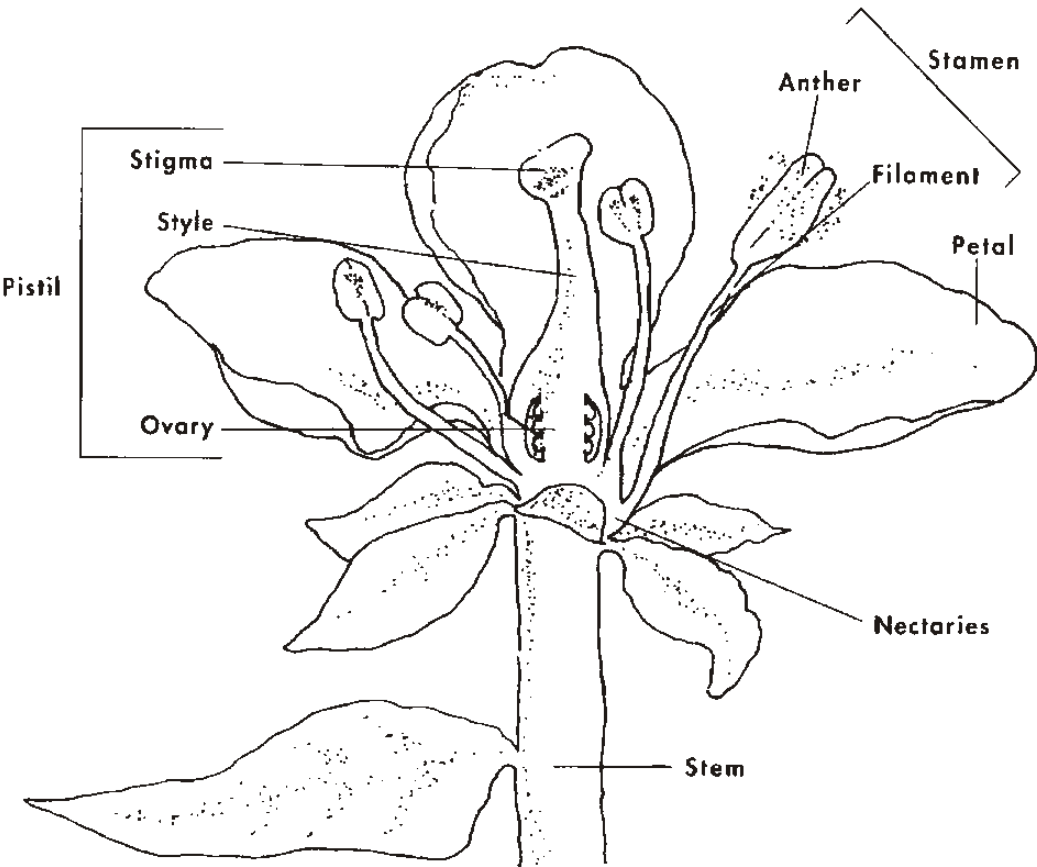

A Beekeeper's Equipment

Using the list of hive elements and beekeeper's tools, label the following.

- | | |
|----------------------------|-------------|
| Bottom board | Honey super |
| Coveralls | Inner cover |
| Frame | Outer cover |
| Gloves | Smoker |
| Hive body or brood chamber | Veil |
| Helmet | |

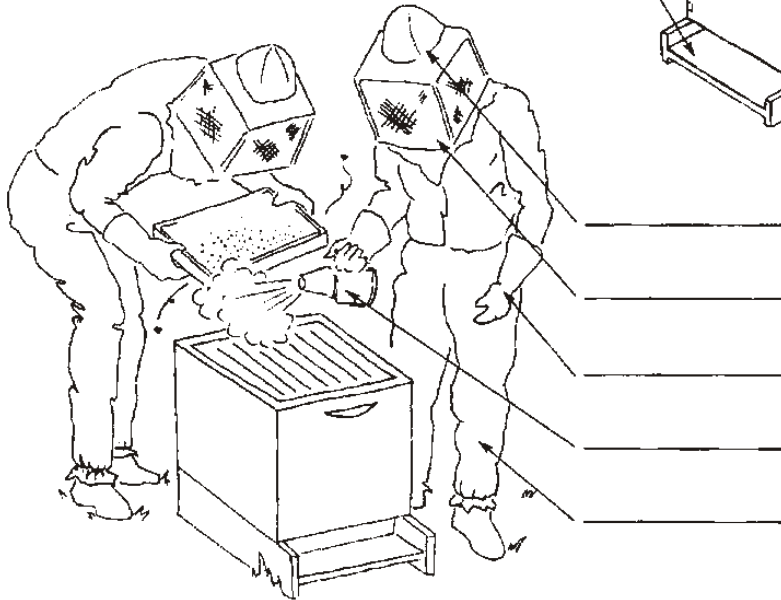
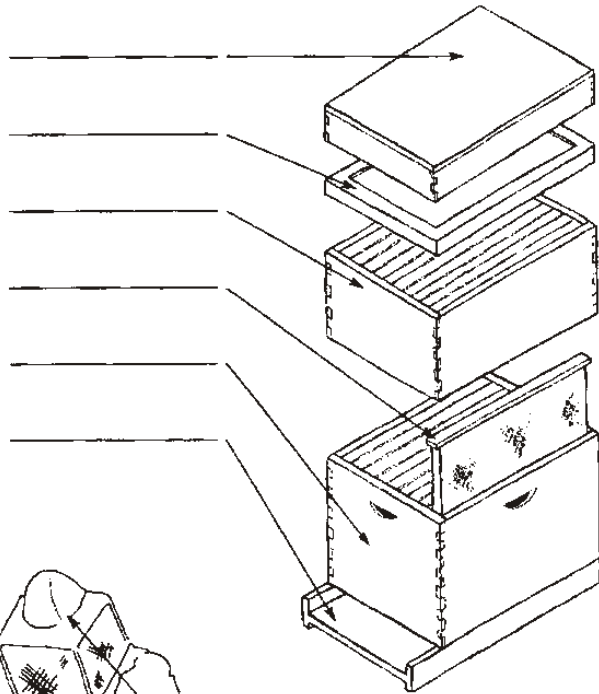

Bottom board
 Coveralls
 Gloves
 Frame
 Hive body or brood chamber
 Helmet
 Honey super
 Inner cover
 Outer cover
 Smoker
 Veil

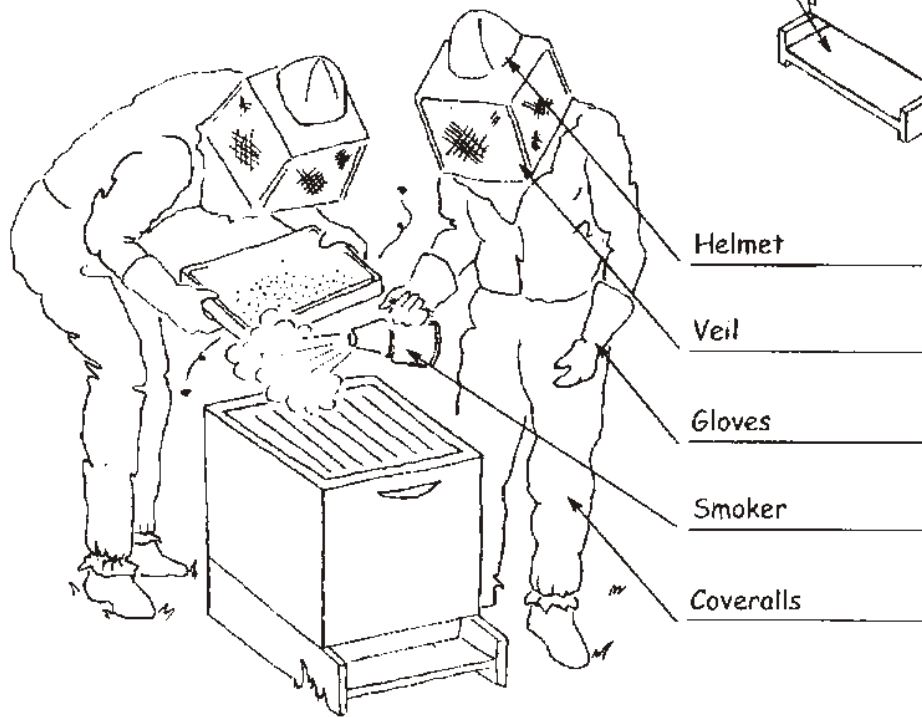
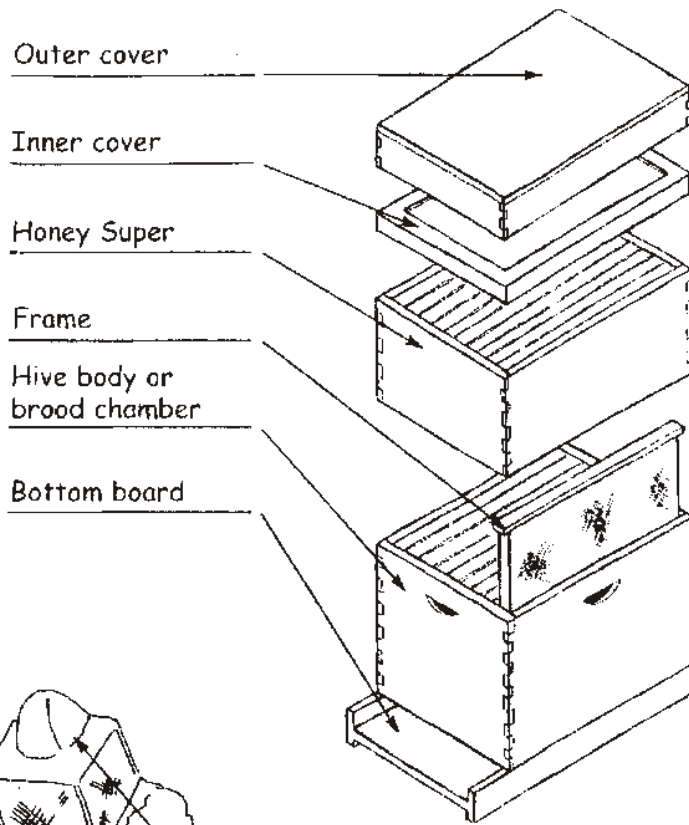

Bee Dance Procedures 4a.

Round Dance



If the flowers are close by, the bee does the *round dance*.

Waggle Dance

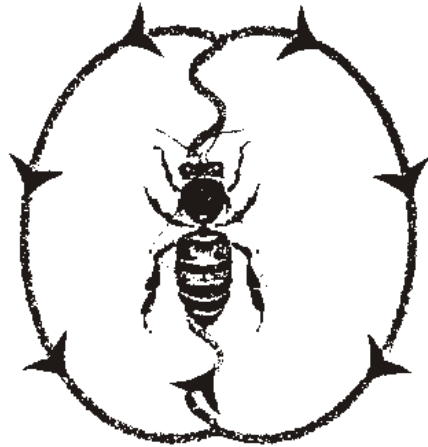

If the flowers are far away, the bee does the *waggle dance*.





Bugs at Home

There once was a tick
Whose name was Tock,
He made his home
Beneath a rock.

There once was a bee
Whose name was Clive,
He made his home
Inside a hive.

There once was a spider
Whose name was Jeb,
He made his home
Out of a web.

There once was an ant
Whose name was Jill,
She made her home
Inside a hill.

Rock, hive, web, hill,
You can believe me or not as you will.
If they're not gone, they're living there still.
Tock, Clive, Jeb and Jill!

—Helen H. Moore



★ Booklink

Bugs by Nancy Winslow Parker and Joan Richards Wright (Greenwillow, 1987).





Bugs



June Bug, stink bug,
Ladybug, chinch bug,
Water bug, pink bug,
Please-don't-pinch bug!

Horsefly, housefly,
Dragonfly, deer fly,
Firefly, fruit fly,
Buzzing-in-your-ear fly!



Honeybee, bumblebee,
Queen bee, drone bee,
Worker bee, nurse bee,
Leave-me-alone bee!



Gypsy moth, luna moth,
Beetle and mosquito.
Bugs and insects
Really are neat-o!



Cockroach, katydid,
Cricket and cicada,
Grasshopper, mantis,
Catch you all later!



—Meish Goldish



Learning Log

Name _____

Date _____

Activity _____

1. What I did:

2. What happened:

3. What i learned:

4. Did I do a good job?

Vocabulary Words:

Bee: A social 4-winged insect often kept in hives for the honey that it produces.

Beehive: A hive for bees: resembling a dome-shaped beehive.

Beekeeper: A person who raises bees.

Flower: blossom; a shoot of a higher plant that is specialized for reproduction.

Fruit: The usually edible reproductive body of a seed plant.

Pollen: Tiny particles in the anthers of a flower that fertilize the seeds and usually appear as fine yellow dust.

honey comb: A mass of six-sided wax cells built by honeybees in their nest to contain young bees and stores of honey.

Eggs: Laid by a queen bee, this is the first stage in the life of a honeybee.

Larvae: Hatched from the egg the queen bee lays, the larvae will pupate and eventually turn into an adult insect.

Nectar: A sweet liquid given off by plants and used by bees in making honey.

Wax: a yellowish plastic substance produced and given off by bees and used by them for making the honey comb.

Colony: A population of plants or animals in a particular place that belong to one species.

Apiaries: A place where bees are best kept; a collection of beehives.

Bumble Bee Mobile

by Julie McGuffee

Take a buzz through the garden with a honey bee mobile. Did you know that bees can fly 22 miles per hour and their wings beat 180 beats per second? You'll really need to be "buzzing" to keep up with them. Bees unwittingly carry pollen on their back legs from flower to flower so that the plant can produce seeds for the next crop.

You will need:

- 4 Styrofoam 2" eggs
- 3" Styrofoam egg
- 24 Yellow 6mm chenille stems
- 18 Black 6mm chenille stems
- Wiggle eyes
- Black craft wire
- Jute
- 16 large wood teardrops
- 2 Small wood rectangles
- White acrylic paint
- Paint brush
- Glue
- Nylon thread
- 18 gauge Wire stem
- Wire snips

Instructions:





Wrap egg with yellow and black chenille stems.



Form chenille into circle. Affix to ends of egg.

1. Wrap each 2" styrofoam egg with yellow chenille stems. Starting at the widest part of the egg, push one end of a stem into the styrofoam then wrap the chenille between the yellow for stripes. To cover each end, form black chennile stem into a circle. Bend the ends outward then attach one circle to each end of the egg by pushing the ends into the body. Secure with glue.
2. Cut one chenille stem into 6 pieces. Push ends into the body then bend to make legs.
3. Paint the wood teardrops white. Let dry then push the pointed ends of four teardrops into each bee. To make antennae, cut 6" piece of craft wire. Fold in half then twist together. Curl each end around a paintbrush handle. Fold in half then push head. Glue wiggle eyes in place.
4. Unbend four paperclips. Push one into the top of each bee for a hanger.
5. Unbend a paperclip then push into the pointed end of the large styrofoam egg. Tie end of jute to the clip. Cover part of the egg with glue, then wrap the egg completely with jute keeping strands close together. Paint the rectangles white. Let dry then write "HOME SWEET HOME" on one side with the black marker.
6. To assemble, cut the wire stem in half then tie the two pieces together at the center to make a cross. Curl each end to make a hook. Tie invisible thread to each bee then tie the opposite ends to the ends of the wire. Tie the beehive to the center of the crossed wires. Glue the rectangles together on either side of the thread with the lettering to the outside.

Darice® Chenille Stems, Wiggle Eyes, Craft Wire, Jute, Wood Teardrops and Rectangles, Wire Stem; Delta Ceramcoat® Acrylic Paint; Dow Styrofoam® Brand Plastic Foam; Elmer's® School Glue; Fiskars® Softouch® Craft Snips; Eagle® Paint Brush.

TRUE / FAISE



1 BEES HAVE FIVE EYES.

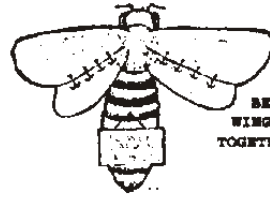

2 BEES HAVE 4 WINGS THAT HOOK TOGETHER IN FLIGHT.



3 BEES EAT FLOWERS.



4 YOU CAN TELL A BEE'S AGE BY ITS WINGS.



5 HONEY BEES ARE REALLY WASPS AND HORNETS.



6 BEEKEEPERS USE SMOKE TO KEEP BEES FROM STINGING.



7 BEES CAN STING MANY TIMES.



8 BEES HAVE SPECIAL HAIR BASKETS TO CARRY POLLEN.



9 BEES CROSSED THE ATLANTIC OCEAN WITH THE COLONISTS.



10 BEES CANNOT SEE RED.

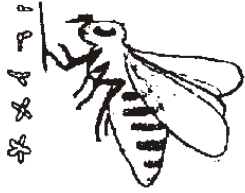

11

BEES CAN COUNT.



12

INSECTICIDES DON'T HURT
HONEY BEES.



13

BEES AND SPIDERS HAVE SIX
LEGS AND ARE INSECTS.



14

HONEY
IS
REALLY
BEE
SPIT.

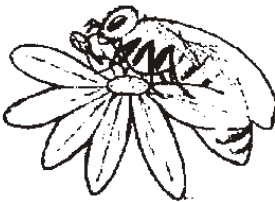

15

SOME FLOWERS
HAVE MARKINGS
ONLY BEES
CAN SEE.



16

A BEE'S HEART IS ON
ITS BACK.

ANSWERS TO THE TRUE/FALSE QUIZ

1. **TRUE** - Bees (**and** all insects) **have** two large compound eyes on either side of their heads **and** three four wings. **Before** a bee leaves the hive, **and** simple eyes on top of their head. With the **compound** her wings she has greater lift and strength while flying. When entering the hive again, she will un-hook her wings so that they will not take up so much space.
2. **TRUE** - Bees **and** their relatives **actually** have compound eyes on either side of their heads **and** three four wings. **Before** a bee leaves the hive, **and** simple eyes on top of their head. With the **compound** her wings she has greater lift and strength while flying. When entering the hive again, she will un-hook her wings so that they will not take up so much space.
3. **FALSE** - Bees collect nectar (the sweet sugar sap make) and pollen (the powder that pollinates the summer; they literally kill themselves with work. Sugars in the nectar are converted into honey, and the protein-rich pollen, is mixed with out.honey and is made into bee bread.
4. **TRUE** - Worker bees live only six weeks during flowers (the powder that pollinates the summer; they literally kill themselves with work. Sugars in the nectar are converted into honey, and the protein-rich pollen, is mixed with out.honey and is made into bee bread.
5. **FALSE** - Bees, while related to wasps and hornets, live in tree hollows, make wax combs and filling their stomachs and making them heavy. It gather only nectar **and** pollen. Wasps and hornets beesmake their homes of paper, mud or live **underground**, release when disturbed. Instead of exciting more make no honey or wax, sting more readily and prey bees with the release of this odor, smoke distracts potential stingers.
6. **TRUE** - Smoke causes bees to gorge honey, are gentler, also masks any of the alarm odor that the guard beesmake their homes of paper, mud or live **underground**, release when disturbed. Instead of exciting more make no honey or wax, sting more readily and prey bees with the release of this odor, smoke distracts potential stingers.
7. **FALSE** - A close examination of the sting barb of a **honeybee** shows that it has tiny hooks on it. When stinging a person or animal, the hooks catch in the skin and as the bee tries to fly off it pulls out its entire stinging organ, thus killing it. Wasps and hornets have smoother sting barbs, which will not grains.snag; they can therefore sting a person repeatedly.
8. **TRUE** - Since flowers and bees **evolved** together 60 million years ago, each has eloped special functions for their mutual benefit. For bees, one such special feature is their hind legs, which serve as a press **and** basket to collect pollen
9. **TRUE** - Honeybees are not native to the New World. The first recorded introduction of bees was to Massachusetts by Puritan colonists in the 1630's. they were needed to pollinate the recently introduced however see red, which appears as black to them. apple trees!
10. **TRUE** - Bees, unlike many insects, have refined color vision. Not only do they see blues and yellows but also the invisible ultra-violet light. They cannot see red, which appears as black to them. apple trees!
11. **TRUE** - Research has shown that bees can distinguish one, two, three, four, five and many petals hives worldwide, is the improper and careless use of on flowers. 'they **can** also find their **hive** in a row of **insecticides** toxic to **honey bees**. **Pleas be** considerate next time you use any of these products.
12. **FALSE** - One of the principle losses of bee 14. **FALSE** -honey comes from flower nectars. When a bee visits a flower, she sucks up the sweet
13. **FALSE** - Bees and all insects have six legs and sap with her long tongue into an inflatable sack, ,three body pans (head, thorax, abdomen). Spiders, called a honey stomach. When it is full, the bee mites **and ticks**, called **arachnids have eight legs and returns to the hive**, regurgitates the drop of nectar into the honeycomb, **and** evaporates out the water by fanning. Nectar is about 110% water while honey is only 17%.
15. **TRUE** - Since **honeybees and** flowers co-evolved (see #11), a special feature of many flowers to attract **pollinating** bees is to **have** markings invisible to all but bees. These marks, called nectar guides, position Openings in the vein allow the free-flowing blood to the bee so it will **pollinate the flower, while** **enter the heart and be pumped towards** the wingsrewarding the bee with sweet nectar and protein-rich and head pollen.
16. **TRUE** - The heart of insects is a long vein. which travels along the top of the **abdomen**.



Find the Bee Words!

A	F	B	U	Z	Z	M	I	F	O	I	W	I	N	G	S	Z	H	I	B	R
N	H	G	H	E	I	C	E	L	L	F	O	N	E	B	W	A	I	L	A	O
P	O	L	L	E	N	O	X	O	N	K	C	T	K	E	A	P	V	E	N	L
V	N	O	K	H	E	M	S	W	E	W	O	R	K	E	R	P	E	N	T	S
B	E	V	E	N	C	B	H	E	L	A	M	S	O	W	M	V	T	S	E	G
E	Y	E	P	L	T	H	O	R	A	X	U	P	U	P	A	E	O	I	N	P
E	K	S	R	Y	A	C	M	N	Z	O	I	O	P	D	T	N	O	L	N	H
K	A	H	O	N	R	O	Y	A	L	J	E	L	L	Y	G	O	L	R	A	E
E	G	G	P	S	W	L	Q	B	V	E	I	L	N	T	S	M	O	K	E	R
E	X	L	O	I	P	O	U	D	R	A	P	I	C	U	L	T	U	R	E	O
P	O	L	L	M	D	B	R	O	O	D	R	N	U	D	A	N	C	E	H	M
E	L	O	I	E	H	Y	K	M	X	R	O	A	I	R	N	X	Y	L	O	O
R	J	N	S	T	I	N	G	E	R	I	L	T	C	O	L	O	N	Y	N	N
A	P	B	E	P	V	E	N	N	C	Q	U	E	E	N	K	S	O	L	E	E
L	A	R	V	A	E	T	H	B	F	O	R	A	G	E	R	K	I	R	B	V

Beekeeper
 Pollen
 Buzz
 Larvae
 Pupae
 Egg
 Drone
 Worker
 Queen
 Brood
 Honey
 Nectar

Cell
 Wings
 Thorax
 Abdomen
 Antennae
 Pheromone
 Stinger
 Wings
 Colony
 Dance
 Propolis
 Venom
 Wax

Hive
 Apiculture
 Comb
 Flower
 Pollen
 Royal jelly
 Hive tool
 Smoker
 Veil
 Gloves
 Pollinate
 Forager
 Bee

